

# DOT SHELVING SYSTEM

## Finish for upright:

Anodised aluminium

White lacquered aluminium (similar to RAL 9016) Black

lacquered aluminium (similar to RAL 9004)

## Finish of top:

Aluminium grey lacquered steel (similar to RAL 7042)

White lacquered steel (similar to RAL 9016)

Black lacquered steel (similar to RAL 9004)

## Note:

This bookcase should be assembled taking into consideration the type of wall it will be anchored to.

Add the sketch of the arrangement with the list of each single element to the order (page 350-351).

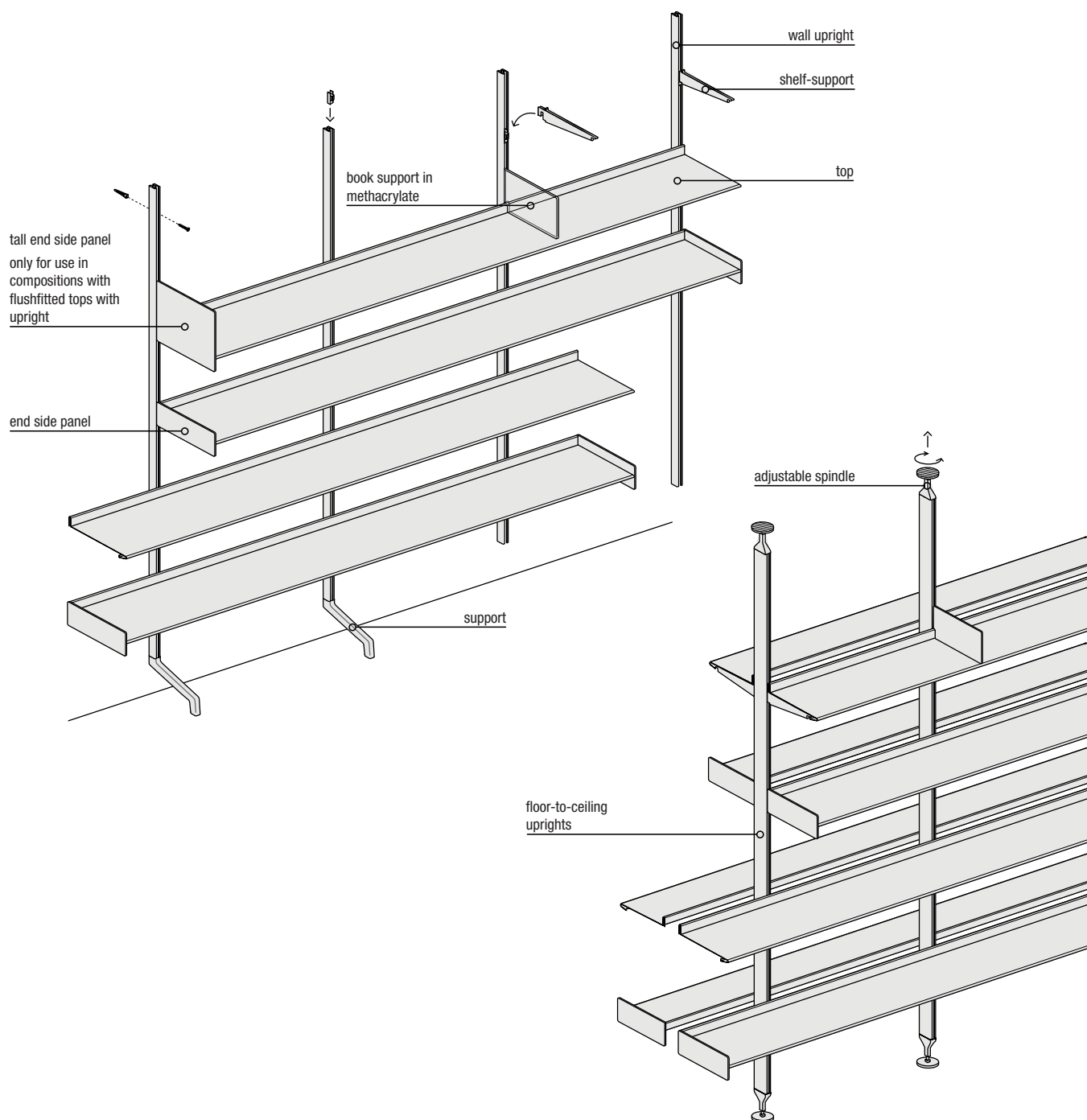

# DOT SHELVING SYSTEM

Wall-fixed bookcase. Wall-hung or floor-standing version.

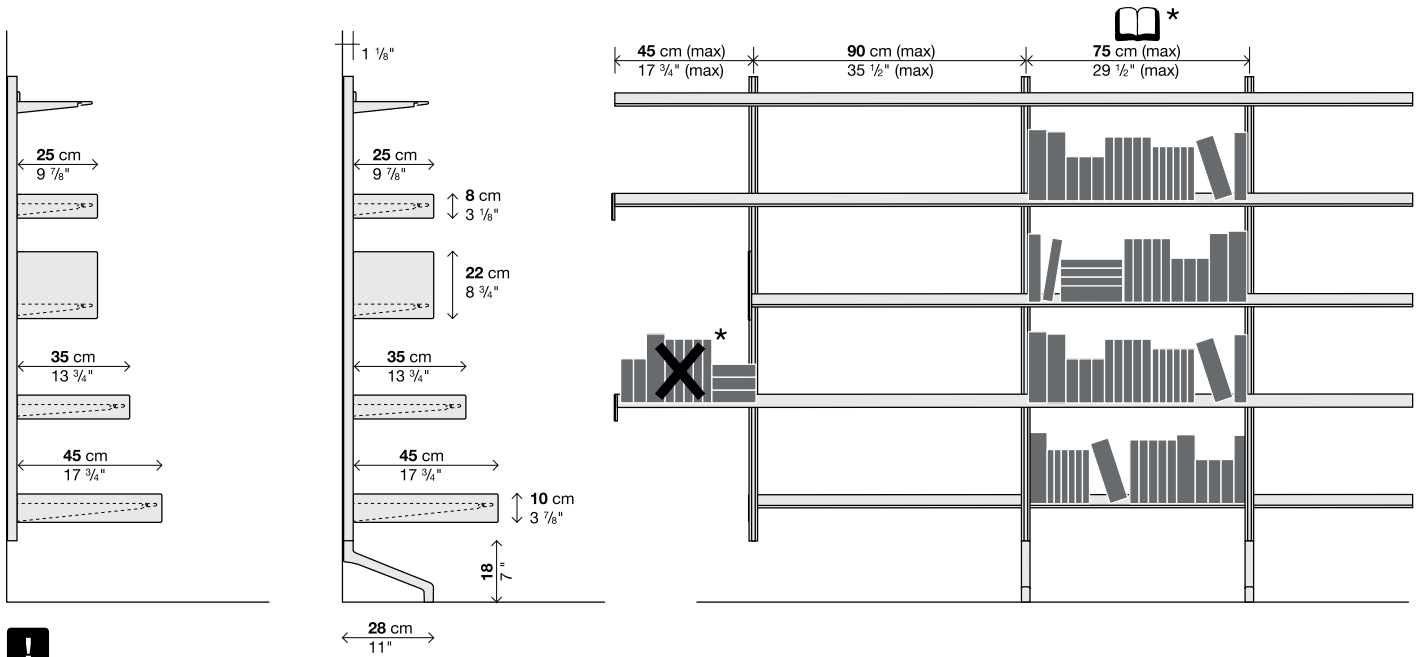

The distance between the uprights must not exceed 90 cm.

In projecting arrangements, it is important not to exceed a projection of 45 cm. Maximum advisable load on the projecting part is **10 kg**.

Shelves can be custom-sized in width and uprights in height.

Maximum advisable load for 25/35 cm deep shelves is **40 kg** (with a distance between uprights of 90 cm), **60 kg** (with a distance between uprights of 75 cm).

Maximum advisable load for 45 cm deep shelves is **30 kg** (with a distance between uprights of 90 cm), **40 kg** (with a distance between uprights of 75 cm).

(\*) For bookshelves, it is advisable not to use offset shelves, and the maximum interval between the uprights must not exceed 75 cm.

Bookcase fixed to the ceiling by means of adjustable thrust devices. Double and single-faced versions are available.

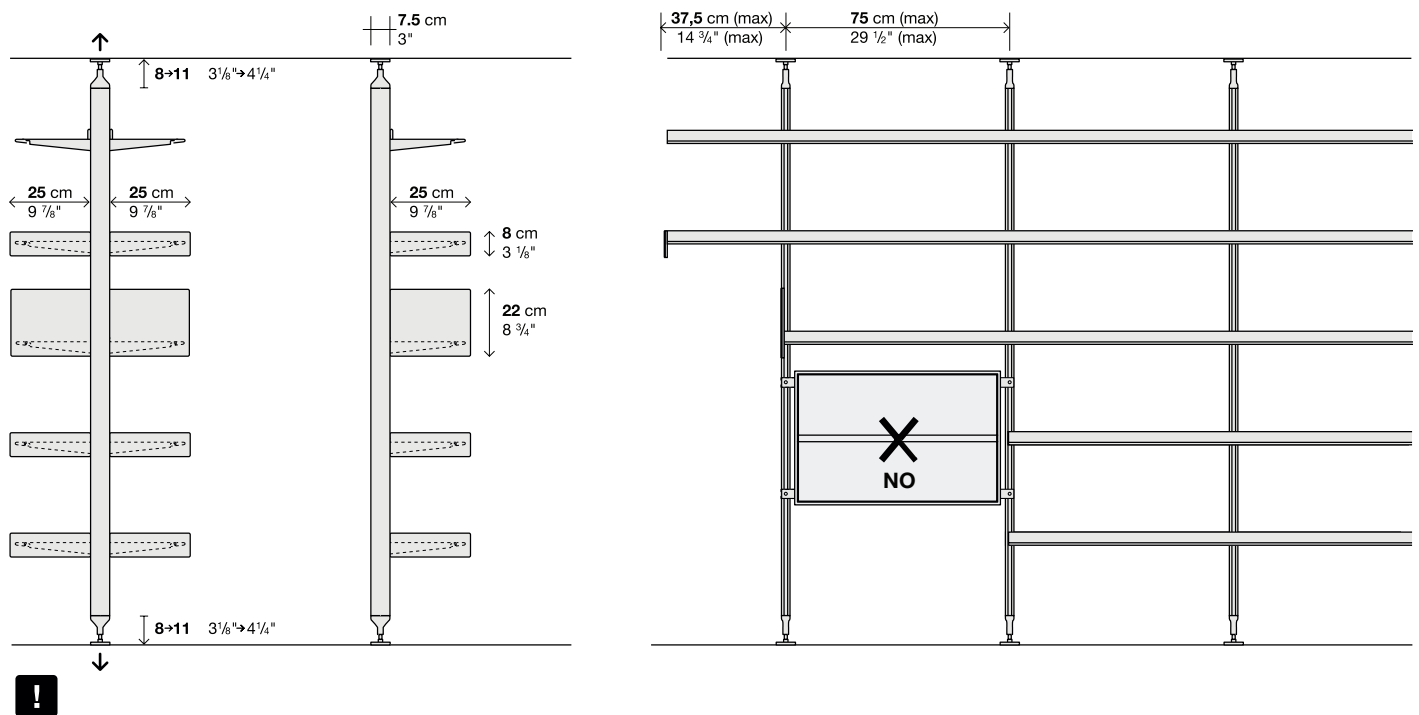

The distance between uprights must not exceed 75 cm.

In projecting arrangements, it is important not to exceed a projection of 37,5 cm. Maximum advisable load on the projecting part is **10 kg**.

Shelves can be custom-sized in width and uprights in height.

For ceiling-fixed bookcases it is advisable to use 25 cm deep shelves only.

Maximum advisable load for 25 cm deep shelves is **40 kg** (with a distance between uprights of 75 cm).

# DOT SHELVING SYSTEM

## Wardrobe

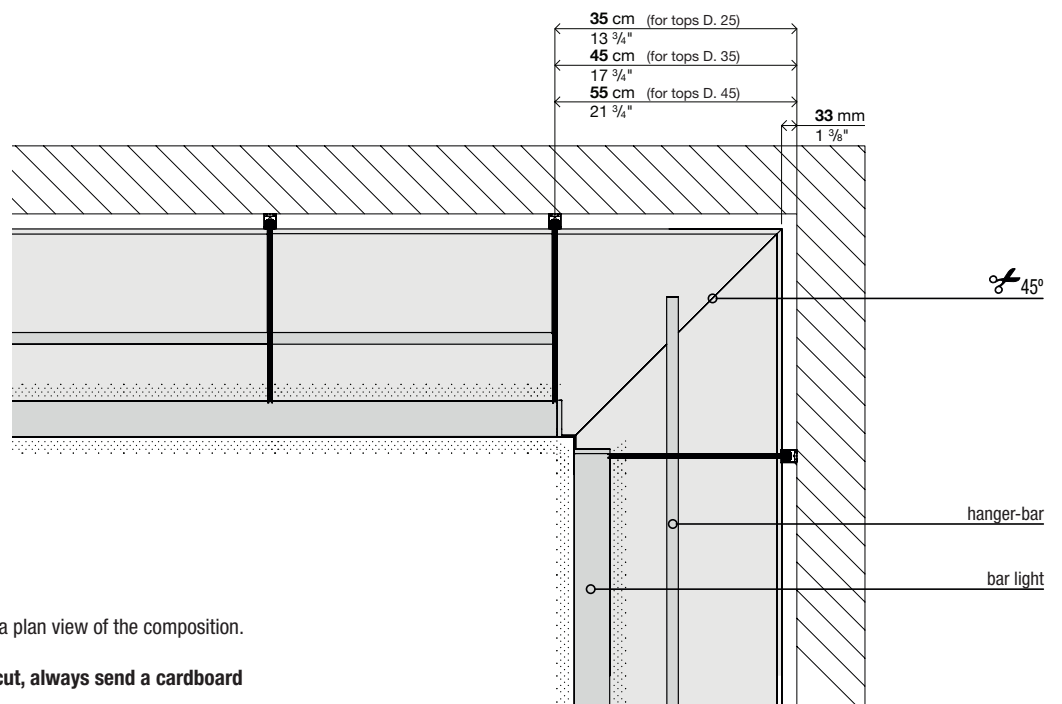
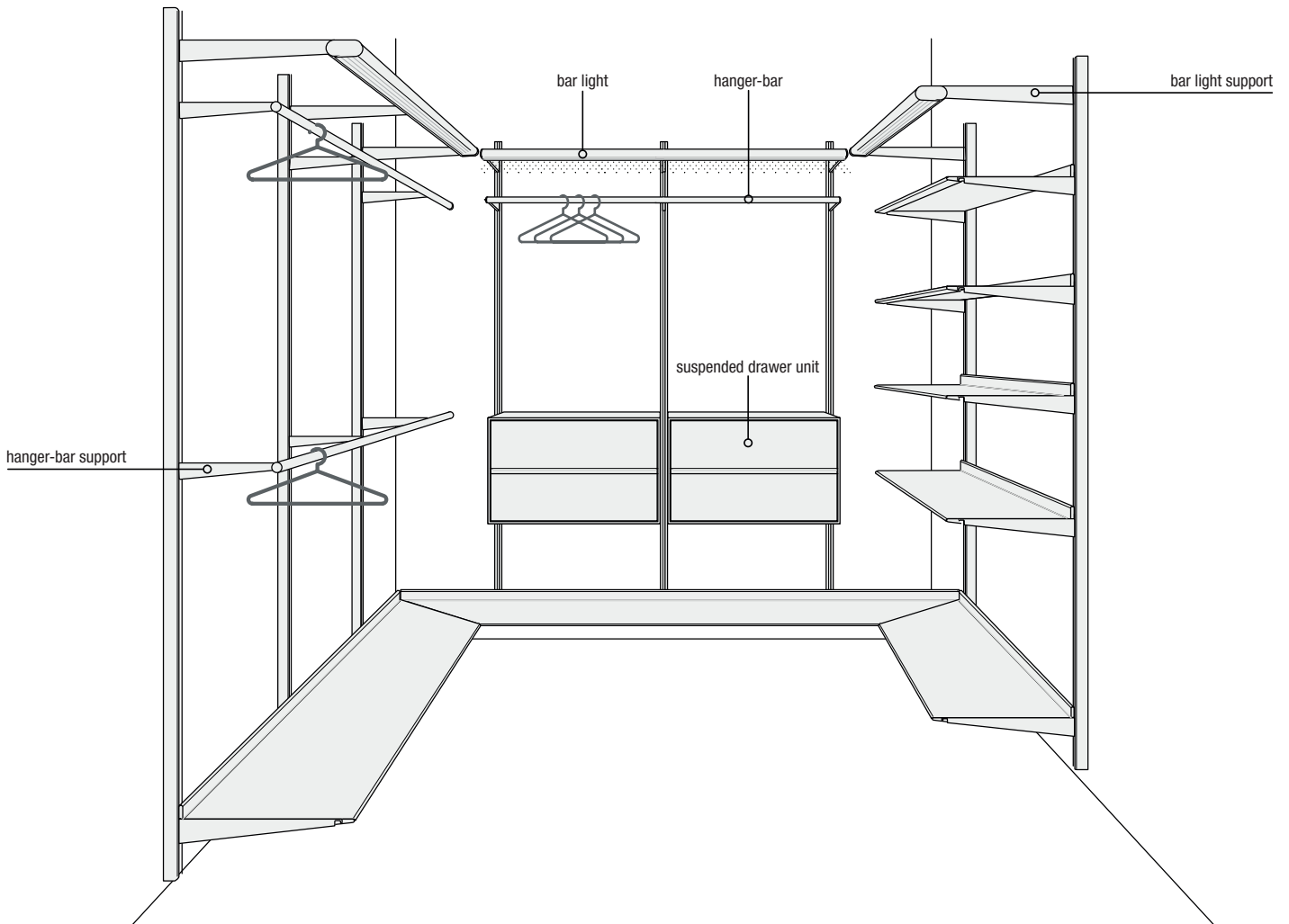

In the case of a corner composition, also give a plan view of the composition. Fill in one form for each wall.

**To ensure that ours is a precision tailored cut, always send a cardboard pattern of the corner.**

# DOT SHELVING SYSTEM

## Wardrobe

Wall walk-in wardrobe with wall mounted drawer units.

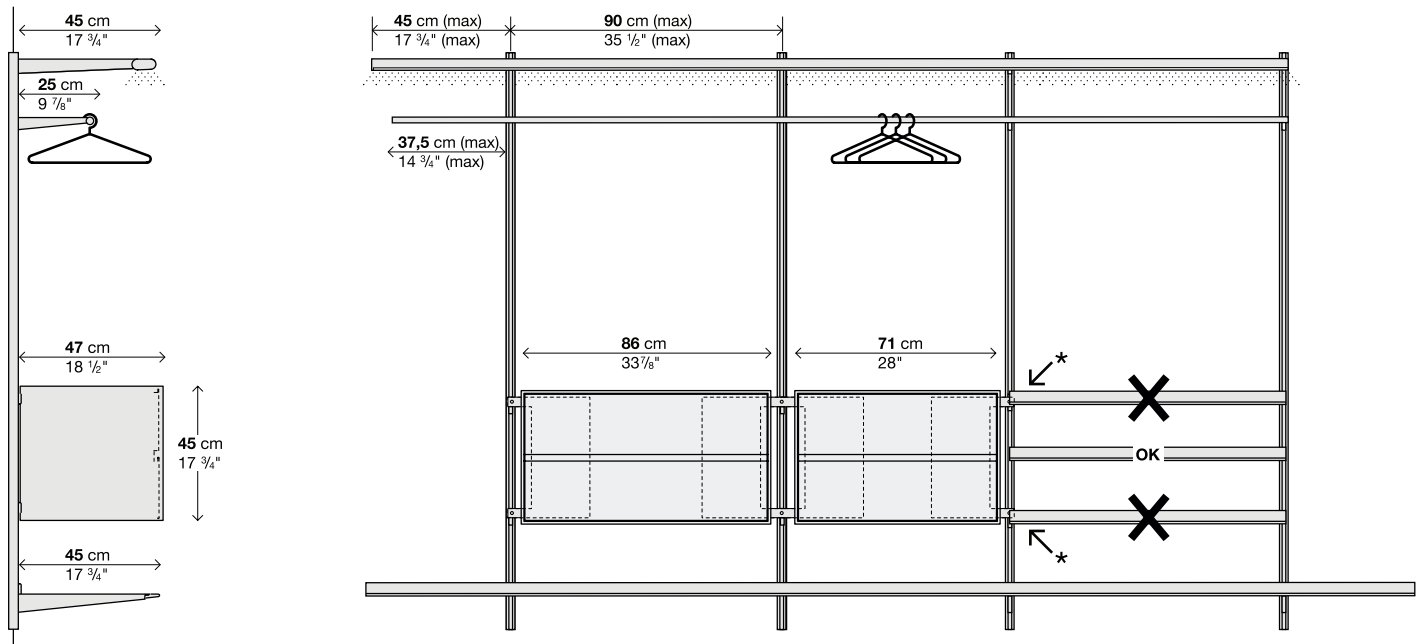

The distance between the uprights must not exceed 90 cm.

The clothes rails and luminous bar can be cut to size.

Shelves can be custom-sized in width and uprights in height.

Maximum advisable load for 45 cm deep shelves is **30 kg** (with a distance between uprights of 90 cm), **40 kg** (with a distance between uprights of 75 cm).

For cantilevered elements it is important not to exceed a projection of 45 cm. Recommended projection bearing capacity is **25 kg**.

(\*) It is not possible to line up other shelves above or under the hanging drawers.

# DOT SHELVING SYSTEM

## Attaching wall-mounted uprights

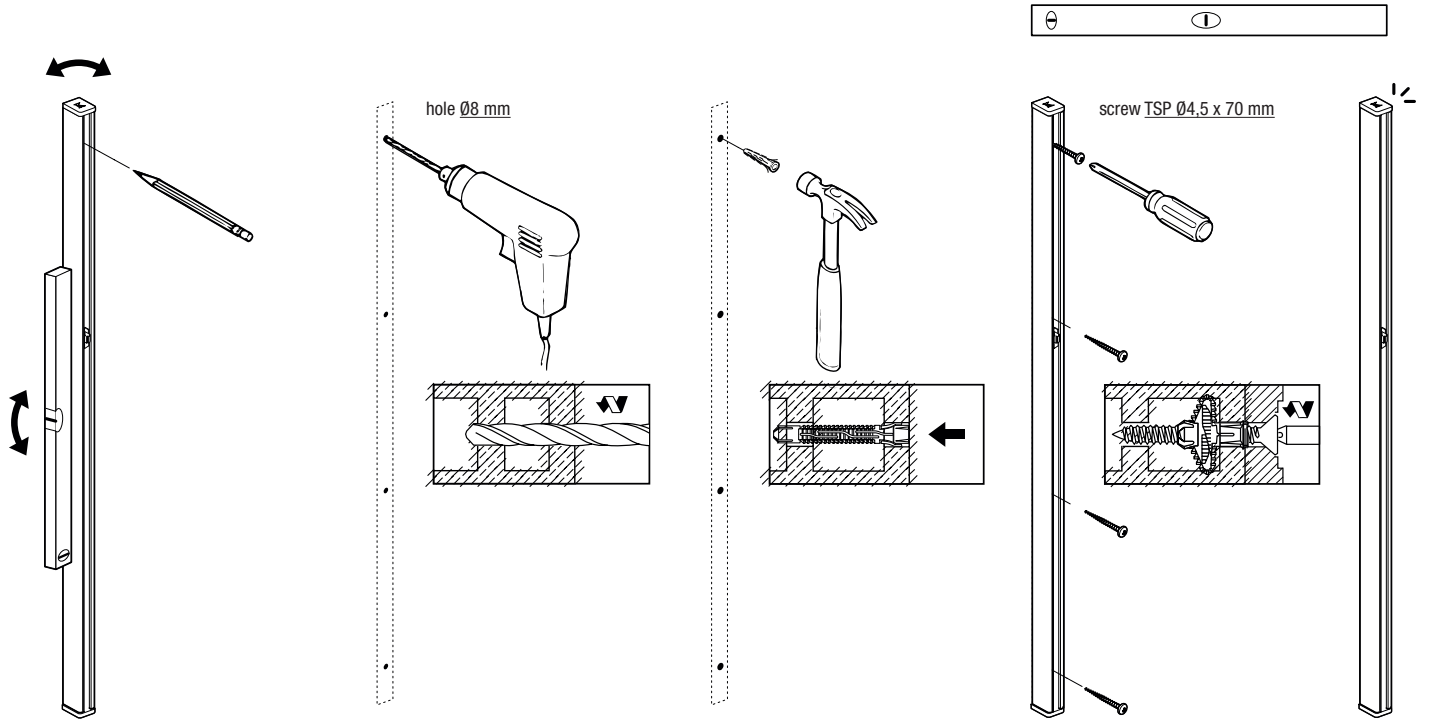

## Real measurements

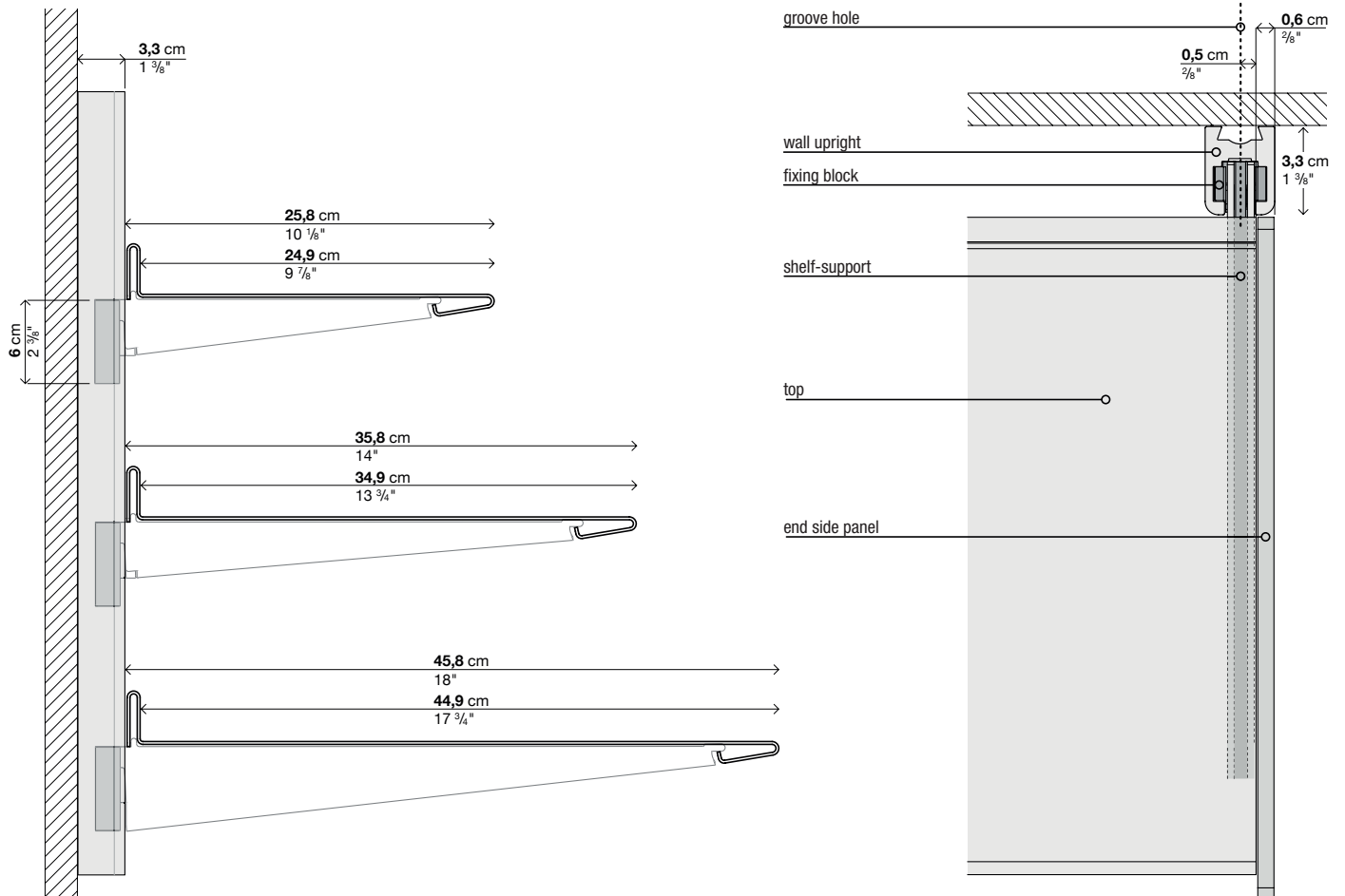

# DOT SHELVING SYSTEM

## Aligning the tops

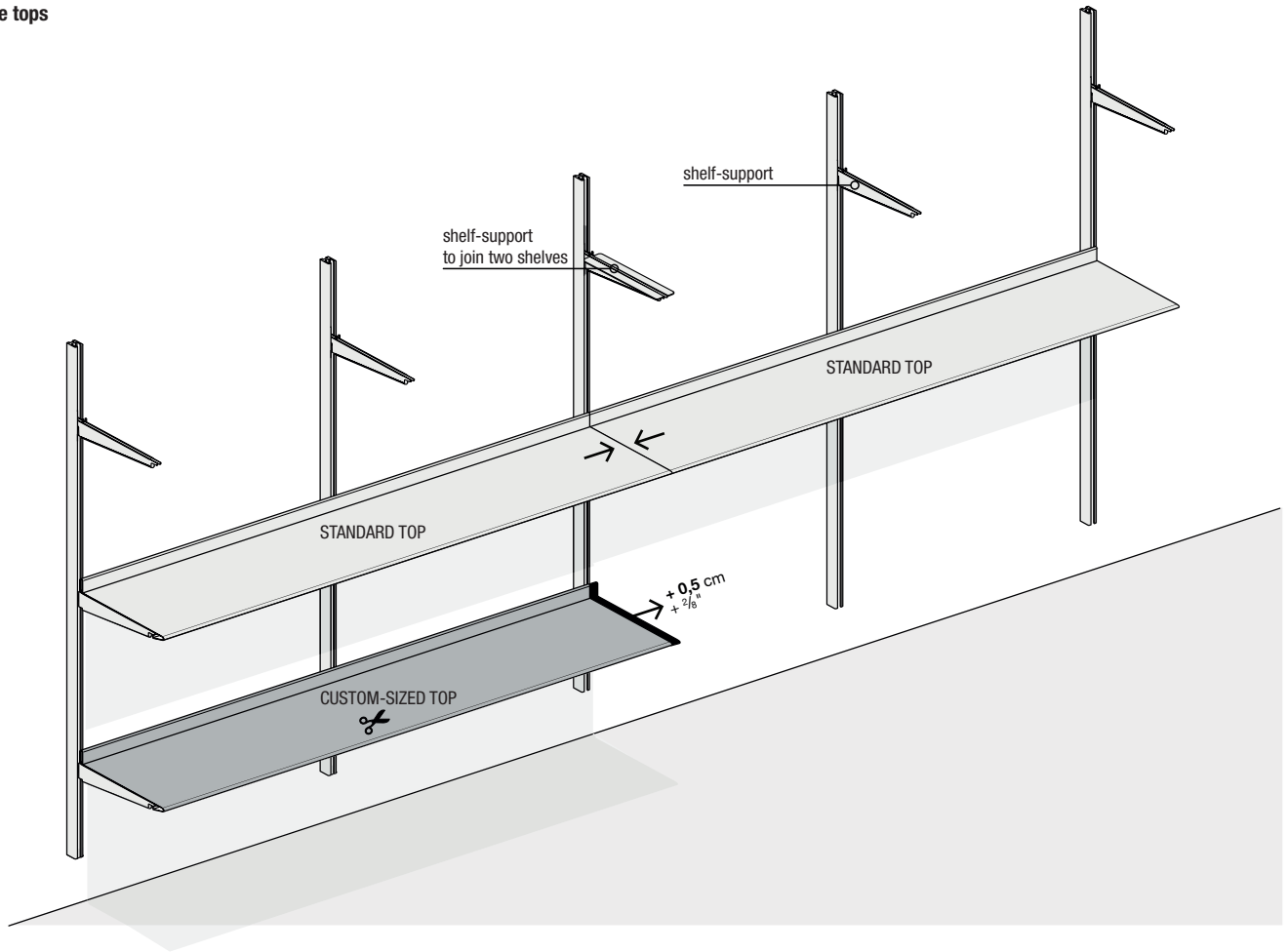

For arrangements that include aligned tops with standard measurements on one level and single tops on other levels, the latter must be made with a custom-sized cut (+ 0,5 cm) for correct alignment.

## Arrangements in a niche

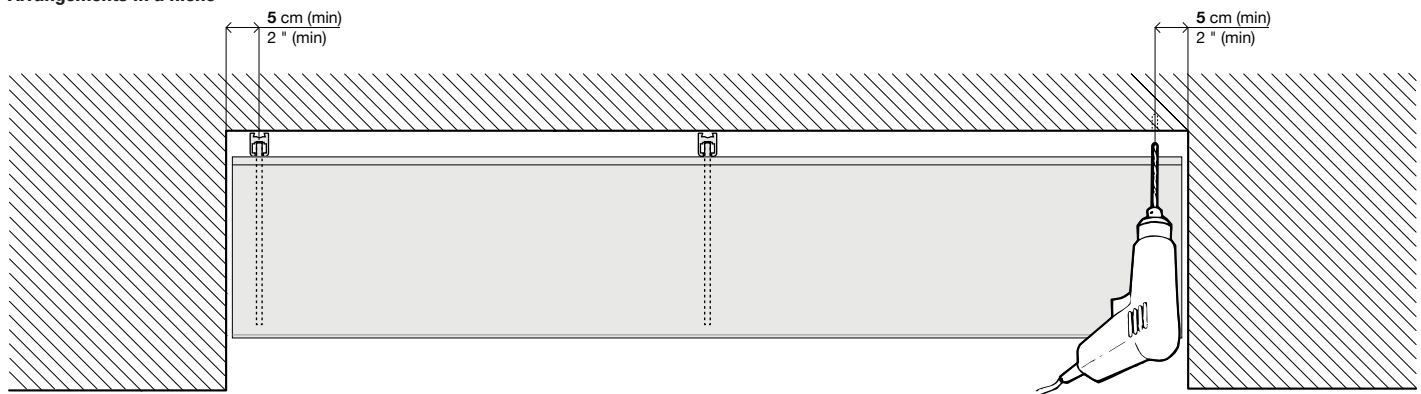

For arrangements in a niche, a minimum distance of 5 cm between the wall and the first gap of the upright is recommended. This space is required for easy drilling.

# DOT SHELVING SYSTEM

## Distance between uprights

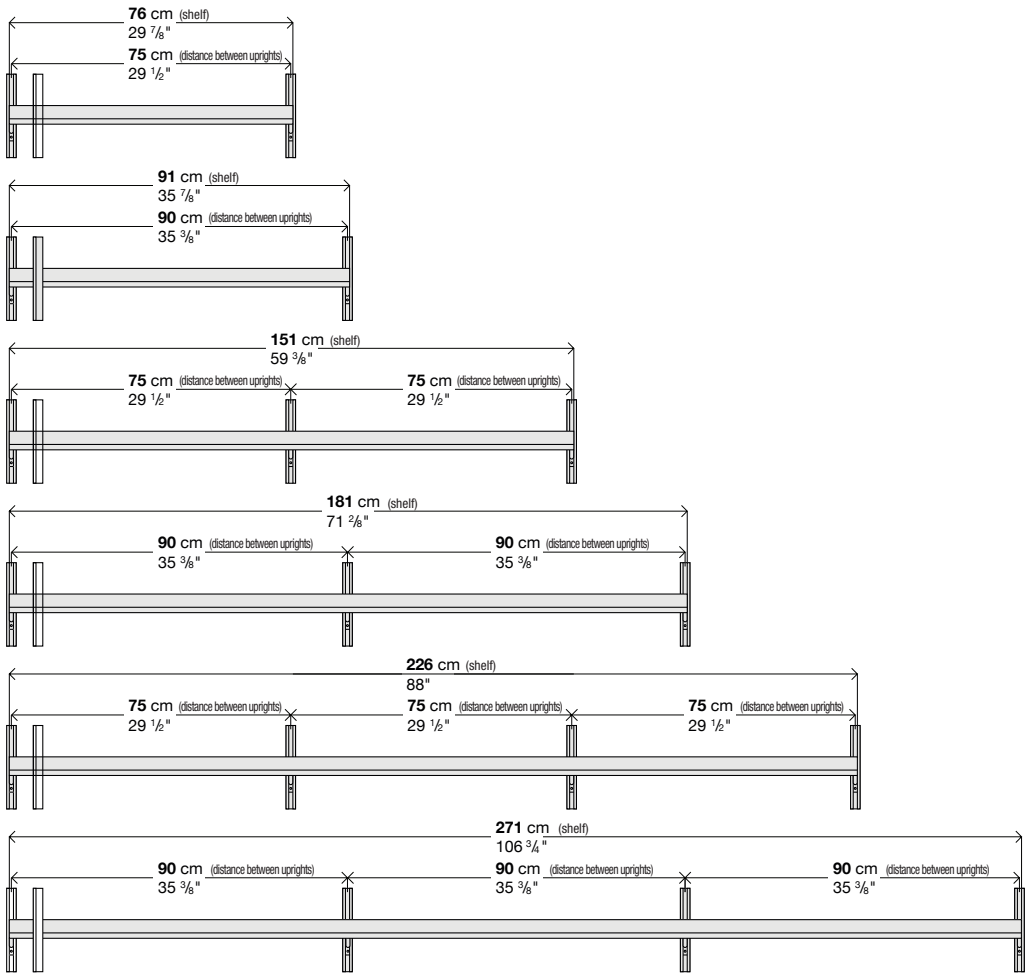

## Wall-fixed bookcase

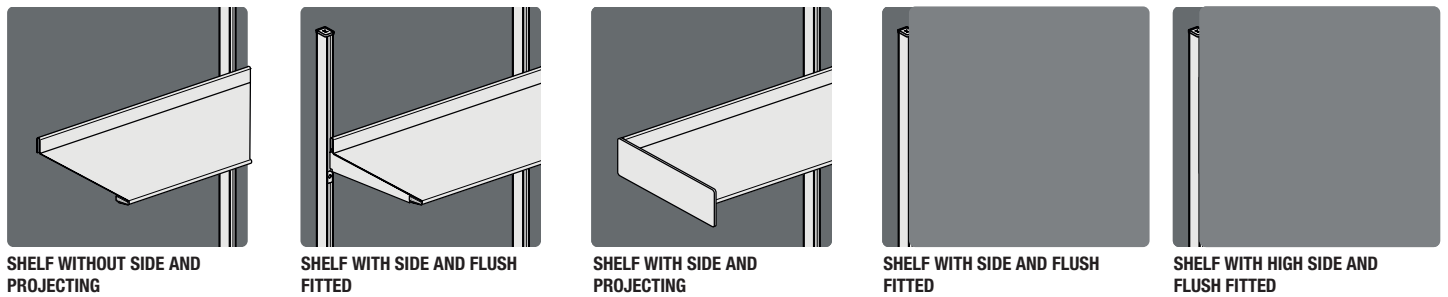

## Bookcase fixed to the ceiling by means of adjustable thrust devices

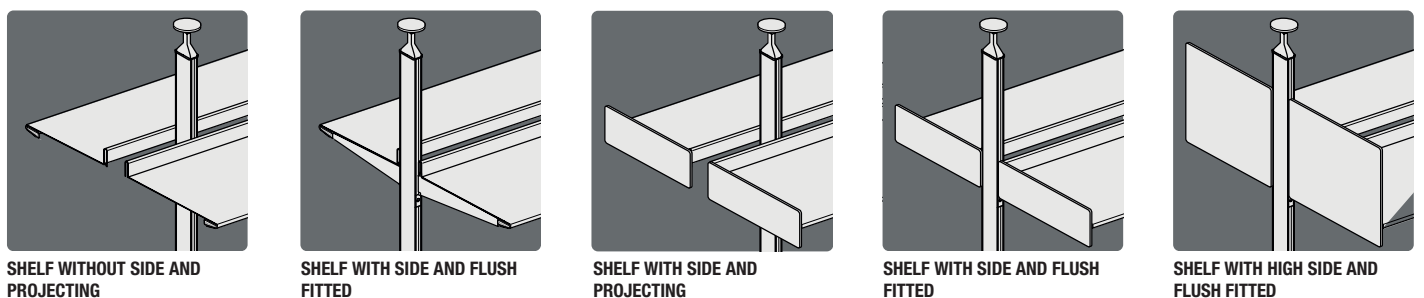

# DOT SHELVING SYSTEM

## Elements

Anodised aluminium wall upright in lacquered or anodised aluminium.

H 60 100 140 180 220 260 cm +  $\frac{1}{8}$ "  
 H 23 5/8" 39 3/8" 55" 70 7/8" 86 5/8" 102 3/8" +  $\frac{1}{8}$ "

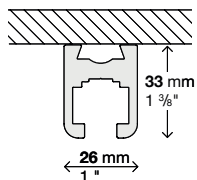

Maximum height for non-standard uprights 3m.

Code	Height	Finish		pack	m <sup>3</sup>	Kg
		Anodised aluminium	Lacquered			
55MOP01	60 cm			-	-	0,6
55MOP02	100 cm			-	-	1,1
55MOP03	140 cm			-	-	1,6
55MOP04	180 cm			-	-	2
55MOP05	220 cm			-	-	2,5
55MOP06	260 cm			-	-	2,9

### Optionals

Code	Height	Finish	pack	m <sup>3</sup>	Kg
55MOP01	60 cm	Anodised aluminium	-	-	0,6
55MOP01	60 cm	Lacquered	-	-	0,6

Aluminium alloy support for floor-standing bookcase.

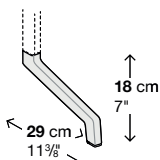

Code	Height	Finish		pack	m <sup>3</sup>	Kg
		Anodised aluminium	Lacquered			
55SOS01	18 cm			-	-	1

Floor-to-ceiling uprights, in lacquered or anodised aluminium.

H 236/242 276/282 316/322 cm +  $\frac{1}{8}$ "  
 H 92 7/8" 95 1/4" 108 3/4" 111" 124 3/8" 126 3/4" +  $\frac{1}{8}$ "

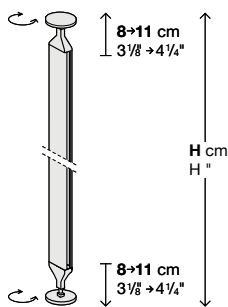
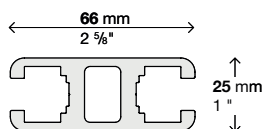

Code	Height	Finish		pack	m <sup>3</sup>	Kg
		Anodised aluminium	Lacquered			
55MOP01	60 cm			-	-	6
55MOP02	100 cm			-	-	6,7
55MOP03	140 cm			-	-	7,5

### Optionals

Code	Height	Finish	pack	m <sup>3</sup>	Kg
55MOP01	60 cm	Anodised aluminium	-	-	6
55MOP01	60 cm	Lacquered	-	-	6

Lacquered steel shelf-support with fixing block.

P 25 35 45 cm  
 D 9 7/8" 13 3/4" 17 3/4"

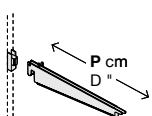

Code	Depth	Finish		pack	m <sup>3</sup>	Kg
		Anodised aluminium	Lacquered			
55REG01	25 cm			-	-	0,4
55REG02	35 cm			-	-	0,5
55REG03	45 cm			-	-	0,7

Lacquered steel shelf-support with fixing block to join two shelves.

P 25 35 45 cm  
 D 9 7/8" 13 3/4" 17 3/4"

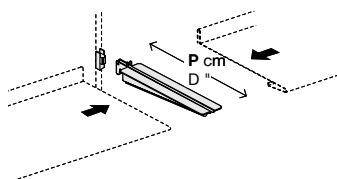

Code	Depth	Finish		pack	m <sup>3</sup>	Kg
		Anodised aluminium	Lacquered			
55REG11	25 cm			-	-	0,5
55REG12	35 cm			-	-	0,6
55REG13	45 cm			-	-	0,8

The specified weights refer to each single piece, packaging not included, since the total amount of products varies depending on each composition.

# DOT SYSTEM

## Elements

### Lacquered steel shelf 25 cm deep.

L 76 91 151 181 226 271 cm + +  
W 29 7/8" 35 7/8" 59 3/8" 71 2/8" 88 7/8" 106 3/4" + +

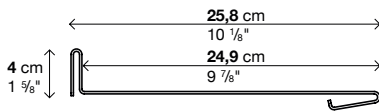
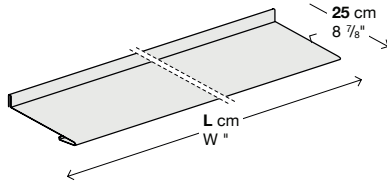

Code	Lenght	Finish	pack	m <sup>3</sup>	Kg
		Lacquered			
55PIA201	76 cm		-	-	4,5
55PIA202	91 cm		-	-	5,3
55PIA203	151 cm		-	-	9
55PIA204	181 cm		-	-	10,5
55PIA205	226 cm		-	-	13,5
55PIA206	271 cm		-	-	16

#### Optionals

Cut to size		-	-	-
A 45° cut		-	-	-

### Lacquered steel shelf 35 cm deep.

L 76 91 151 181 226 271 cm + +  
W 29 7/8" 35 7/8" 59 3/8" 71 2/8" 88 7/8" 106 3/4" + +

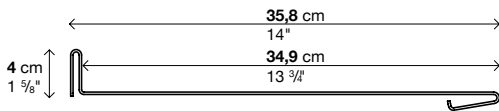
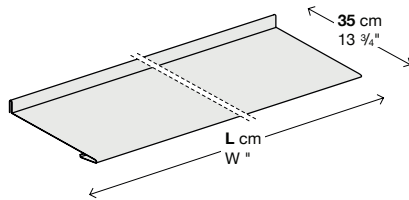

Code	Lenght	Finish	pack	m <sup>3</sup>	Kg
		Lacquered			
55PIA301	76 cm		-	-	6
55PIA302	91 cm		-	-	7
55PIA303	151 cm		-	-	11,5
55PIA304	181 cm		-	-	13,5
55PIA305	226 cm		-	-	17
55PIA306	271 cm		-	-	20,5

#### Optionals

Cut to size		-	-	-
A 45° cut		-	-	-

### Lacquered steel shelf 45 cm deep.

L 76 91 151 181 226 271 cm + +  
W 29 7/8" 35 7/8" 59 3/8" 71 2/8" 88 7/8" 106 3/4" + +

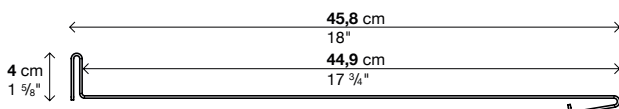
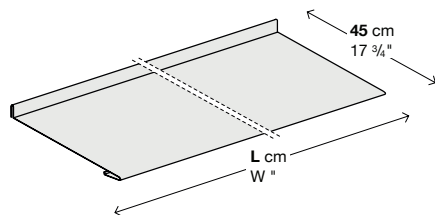

Code	Lenght	Finish	pack	m <sup>3</sup>	Kg
		Lacquered			
55PIA401	76 cm		-	-	6
55PIA402	91 cm		-	-	7
55PIA403	151 cm		-	-	11,5
55PIA404	181 cm		-	-	13,5
55PIA405	226 cm		-	-	17
55PIA406	271 cm		-	-	20,5

#### Optionals

Cut to size		-	-	-
A 45° cut		-	-	-

The specified weights refer to each single piece, packaging not included, since the total amount of products varies depending on each composition.

# DOT SYSTEM

## Elements

Rh/Lh end panel in lacquered aluminium.

P 26 36 46 cm  
D 10 2/8" 14" 18"

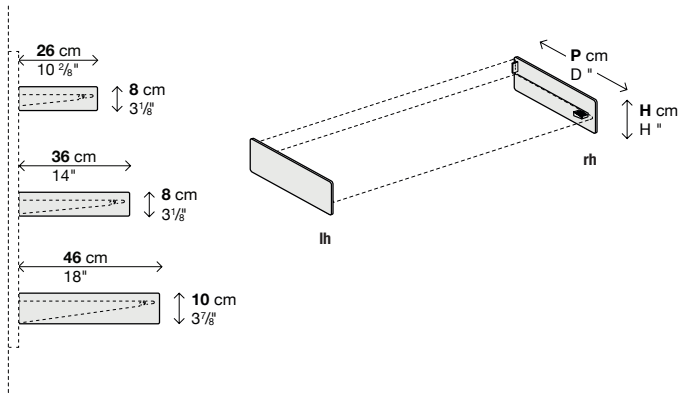

Code	Dimensions	Finish	pack	m <sup>3</sup>	Kg
		Lacquered			
55FIA01D	rh 26 x 8 cm		-	-	0,3
55FIA01S	lh 26 x 8 cm		-	-	0,3
55FIA02D	rh 36 x 8 cm		-	-	0,4
55FIA02S	lh 36 x 8 cm		-	-	0,4
55FIA03D	rh 46 x 10 cm		-	-	0,5
55FIA03S	lh 46 x 10 cm		-	-	0,5

Right/left tall end side panel in lacquered aluminium.  
It acts as a bookend and can be used only in arrangements with tops flush with upright.

P 26 36 cm  
D 10 2/8" 14"

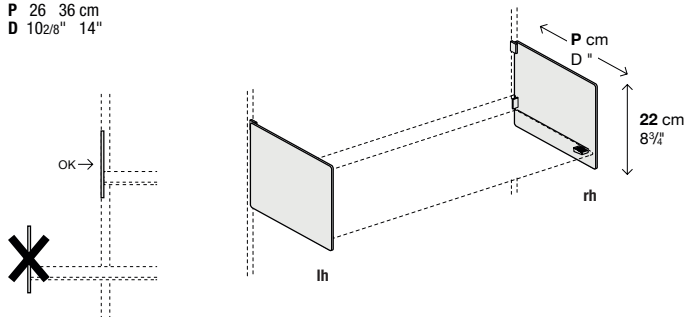

Code	Depth	Finish	pack	m <sup>3</sup>	Kg
		Lacquered			
55FIA11D	rh 26		-	-	1
55FIA11S	lh 26		-	-	1
55FIA12D	rh 36		-	-	1
55FIA12S	lh 36		-	-	1

High book support in satinized methacrylate  
to use lined up with the upright.

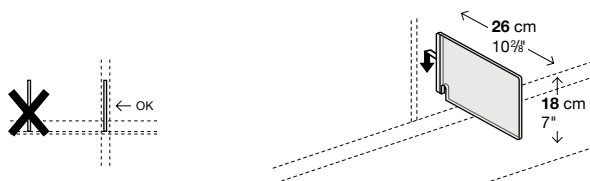

Code	Depth	Finish	pack	m <sup>3</sup>	Kg
		Satinized methacrylate			
55REL11	26		-	-	0,5

The specified weights refer to each single piece, packaging not included, since the total amount of products varies depending on each composition.

# DOT SYSTEM

## Elements

Hanger-bar support, r/l or middle, in lacquered steel with fastening block.

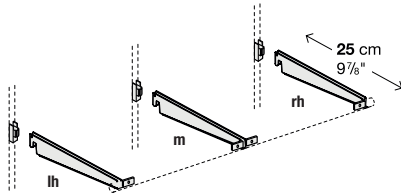

Code	Finish		pack	m <sup>3</sup>	Kg
	Lacquered				
<b>55RAP01D</b> rh	-	-	-	-	0,3
<b>55RAP01C</b> m	-	-	-	-	0,3
<b>55RAP01S</b> lh	-	-	-	-	0,3

Hanger-bar in lacquered or anodised aluminium.

L 76 912 151 181 226 271 cm + ✂  
 W 29 7/8" 35 7/8" 59 3/8" 71 2/8" 88 7/8" 106 3/4" + ✂

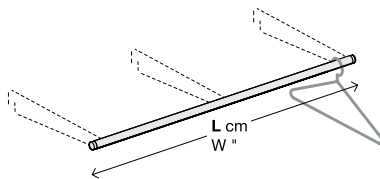

Code	Lenght	Finish		pack	m <sup>3</sup>	Kg
		Anodised aluminium	Lacquered			
<b>55TUB01</b>	76 cm			-	-	0,6
<b>55TUB02</b>	91 cm			-	-	0,7
<b>55TUB03</b>	151 cm			-	-	1,2
<b>55TUB04</b>	181 cm			-	-	1,4
<b>55TUB05</b>	226 cm			-	-	1,7
<b>55TUB06</b>	271 cm			-	-	1,9

### Optionals

Cut to size		-	-	-
-------------	--	---	---	---

Bar light support, r/l or middle, in lacquered steel with fastening block.

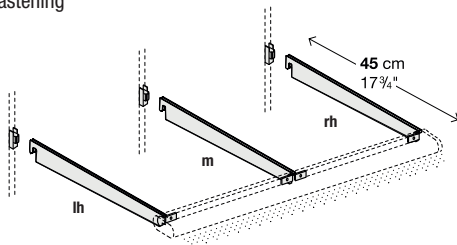

Code	Finish		pack	m <sup>3</sup>	Kg
	Lacquered				
<b>55RAP03D</b> rh	-	-	-	-	0,3
<b>55RAP03C</b> m	-	-	-	-	0,3
<b>55RAP03S</b> lh	-	-	-	-	0,3

Bar light with LED light in lacquered or anodised aluminium. Specify Rh or Lh power supply cable outlet.

L 76 912 151 181 226 271 cm + ✂  
 W 29 7/8" 35 7/8" 59 3/8" 71 2/8" 88 7/8" 106 3/4" + ✂

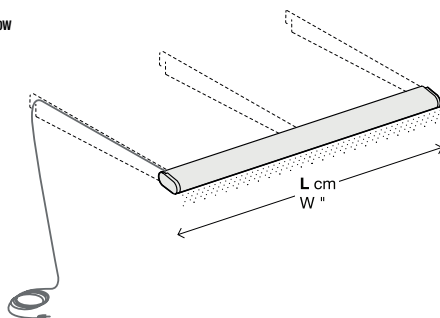

Code	Lenght	Finish		pack	m <sup>3</sup>	Kg
		Anodised aluminium	Lacquered			
<b>55BAR01</b>	76 cm			-	-	1
<b>55BAR02</b>	91 cm			-	-	1,3
<b>55BAR03</b>	151 cm			-	-	2
<b>55BAR04</b>	181 cm			-	-	2,3
<b>55BAR05</b>	226 cm			-	-	2,5
<b>55BAR06</b>	271 cm			-	-	3,2

### Optionals

Cut to size		-	-	-
-------------	--	---	---	---

The specified weights refer to each single piece, packaging not included, since the total amount of products varies depending on each composition.

# DOT SYSTEM

## Elements

Suspended drawer unit in lacquered steel with two full-extension drawers and automatic return.

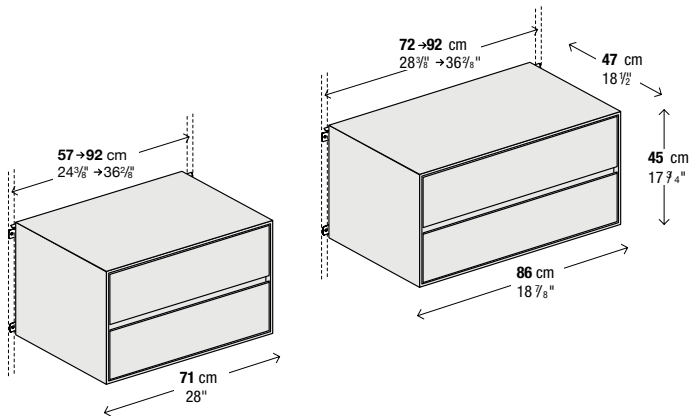

Code	Lenght	Finish	pack	m <sup>3</sup>	Kg
		Lacquered			
<b>55CAS01</b>	71 cm		-	-	37
<b>55CAS02</b>	86 cm		-	-	44

Slip-proof mat for interior drawer.

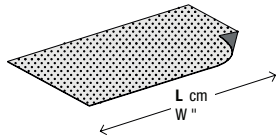

Code	Lenght	Finish	pack	m <sup>3</sup>	Kg
		Slip-proof rubber			
<b>20TAP01</b>	71		-	-	1
<b>20TAP02</b>	86		-	-	1,2

Adjustable supports for suspended drawer units.

For adjoining drawer units, use 55REC01D + 55REC01C + 55REC01S supports.

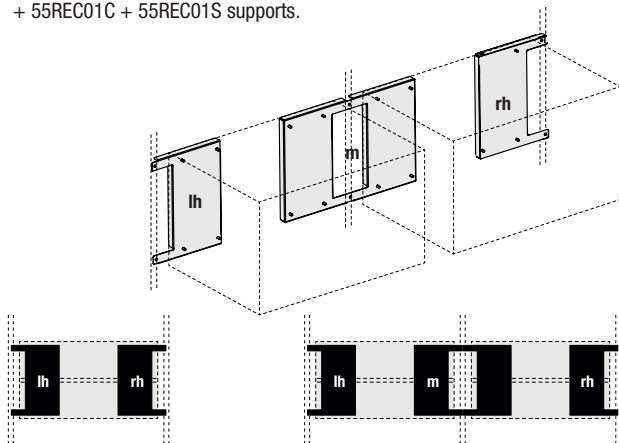

Code		Finish	pack	m <sup>3</sup>	Kg
		Lacquered			
<b>55REC01D</b>	rh		-	-	3,6
<b>55REC01C</b>	m		-	-	5,6
<b>55REC01S</b>	lh		-	-	3,6

The specified weights refer to each single piece, packaging not included, since the total amount of products varies depending on each composition.



### Wall upright

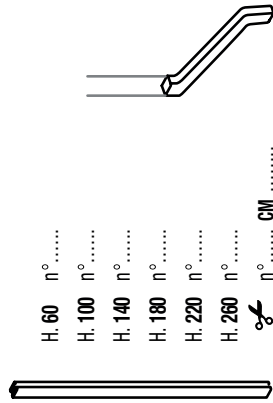

### Support

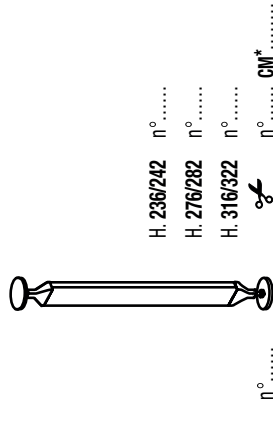

### Floor-to-ceiling uprights

### Shelf-support

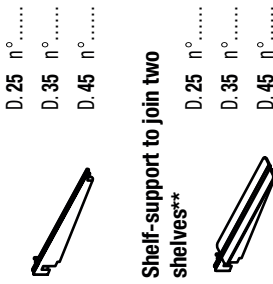

### End side panel R/L

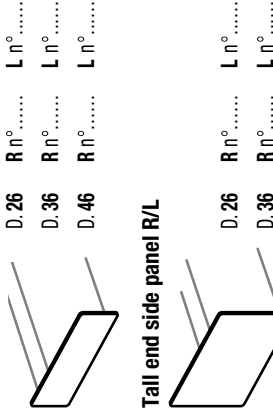

### Shelf-support to join two shelves\*\*



### Tall end side panel R/L

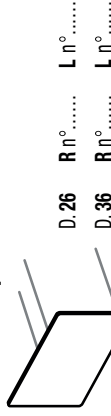

### Book support in methacrylate



### 25 cm deep shelf

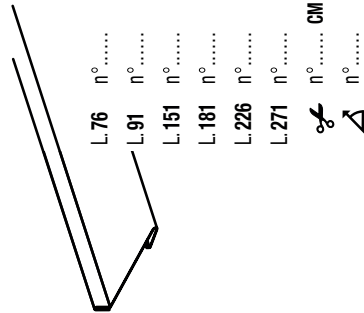

### 35 cm deep shelf

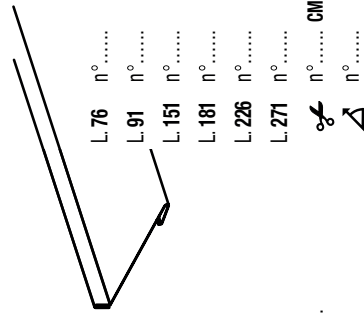

### 45 cm deep shelf

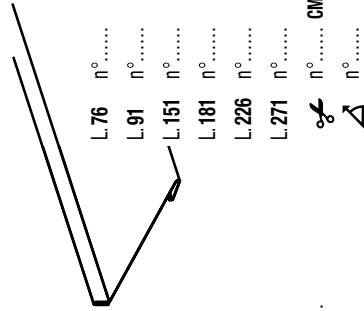

### Suspended drawer

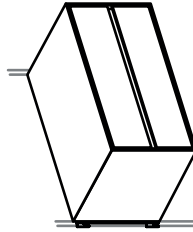

### Slip-proof mat

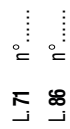

### Hanger-bar support R/M/L



### Hanger-bar

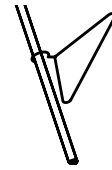

### Bar light

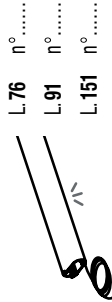

### Bar light support R/M/L



\* Indicate the ceiling height. \*\* To be used when bringing two surfaces together.