



Sideboard in solid wood and blockboard, with iron or wooden frame, characterized by asymmetrical lines created by doors and drawers, assembled with dovetail joints.

STANDARD COMPOSITION: 4 DOORS - 2 ADJUSTABLE SHELVES - 3 DRAWERS

RIALTO MODULO 4.03

CODE	SIZE	STRUCTURE	FRONTS PROCESSING	FRONTS			
				A1	A2	A4	A6
RIALTO MODULO 4.03 WOOD	W.202,6 x D.50 x H.93,5	WALNUT WITH AND WITHOUT KNOTS	FRESART: SOTTILE / MEDIA / MOSSA	■			
			SMOOTH	■			
		OAK WITH AND WITHOUT KNOTS	FRESART: SOTTILE / MEDIA / MOSSA		■		
			SMOOTH		■	■	■
		PIGMENTED OAK WITH AND WITHOUT KNOTS	FRESART: SOTTILE / MEDIA / MOSSA			■	
			SMOOTH			■	
RIALTO MODULO 4.03 METAL	W.202,6 x D.50 x H.93,5	B2	FRESART: SOTTILE / MEDIA / MOSSA	■	■		
			SMOOTH	■	■	■	■
		B3	FRESART: SOTTILE / MEDIA / MOSSA	■	■		
			SMOOTH	■	■	■	■

AVAILABLE FINISHES:

A1: walnut without knots, walnut with knots

A2: oak without knots, oak with knots

A4: oak without knots pigmented: white milk, total black
oak with knots pigmented: white milk, total black

A6: briccola

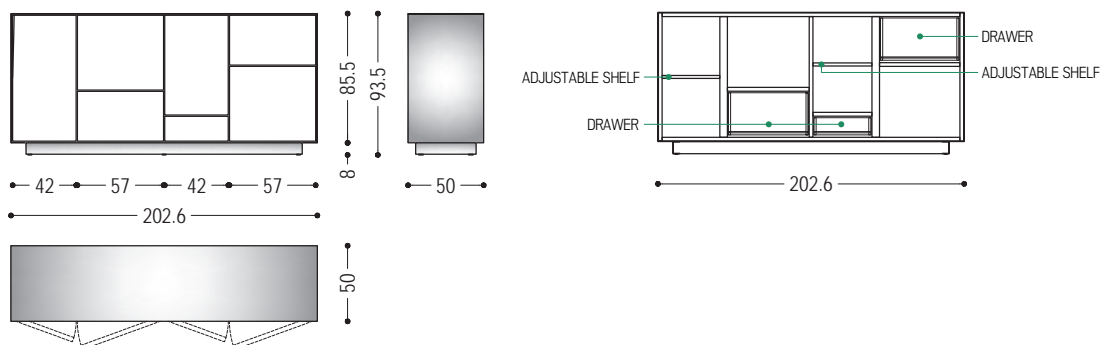

WOOD

A1

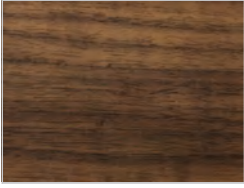

walnut without knots



walnut with knots

A2

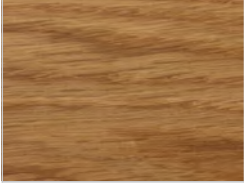

oak without knots



oak with knots

A4



oak without knots pigmented:
white milk

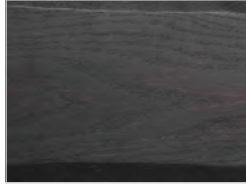

oak without knots pigmented:
total black



oak with knots pigmented:
white milk



oak with knots pigmented:
total black









A6

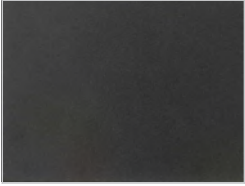
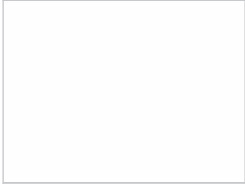

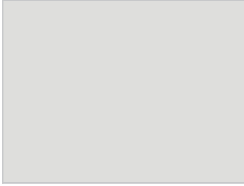
briccola

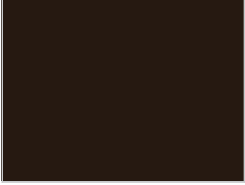
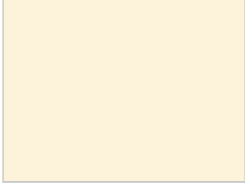
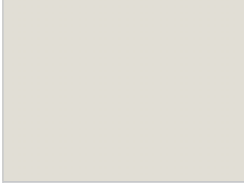
RIALTO MODULO 4.03 | AVAILABLE FINISHES

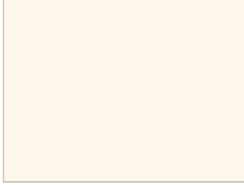
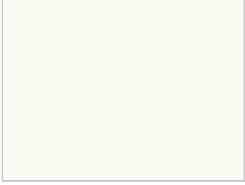
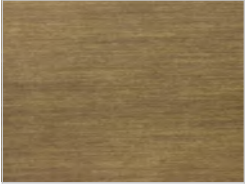
IRON

B2					
	<p>lacquered iron: iron dust</p>	<p>ferro laccato: RAL - 1013_OYSTER WHITE</p>	<p>ferro laccato: RAL - 3020_TRAFFIC RED</p>	<p>ferro laccato: RAL - 7035_LIGHT GREY</p>	<p>ferro laccato: RAL - 7037_DUSTY GREY</p>
					
	<p>ferro laccato: RAL - 8019_GREY BROWN</p>	<p>ferro laccato: RAL - 9001_CREAM WHITE</p>	<p>ferro laccato: RAL - 9002_GREY WHITE</p>	<p>ferro laccato: RAL - 9005_JET BLACK</p>	<p>ferro laccato: RAL - 9010_PURE WHITE</p>
					
	<p>ferro laccato: RAL - 9016_TRAFFIC WHITE</p>				
B3					
	<p>lacquered iron, matt brushed effect: aged bronze</p>	<p>lacquered iron, matt brushed effect: stainless steel</p>	<p>lacquered iron, matt brushed effect: titanium</p>		