



Table with top in solid wood planks, not glued, with natural sides combined with an iron base, consisting of two U-shaped legs and a central bar.

CODE	SIZE	BASE	A1	A2	A4
CALLECULT-1	W.220 x D.90/100 x H.73	B2	■	■	■
		B3	■	■	■
CALLECULT-2	W.240 x D.90/100 x H.73	B2	■	■	■
		B3	■	■	■
CALLECULT-3	W.260 x D.90/100 x H.73	B2	■	■	■
		B3	■	■	■
CALLECULT-4	W.280 x D.90/100 x H.73	B2	■	■	■
		B3	■	■	■
CALLECULT-5	W.300 x D.90/100 x H.73	B2	■	■	■
		B3	■	■	■

**AVAILABLE FINISHES:**

**A1:** walnut with knots

**A2:** oak with knots

**A4:** oak without knots pigmented: white milk  
oak with knots pigmented: white milk, total black

**B2:** lacquered iron: irondust, RAL (only selected colours)

**B3:** lacquered iron matt brushed effect: aged bronze, stainless steel, titanium

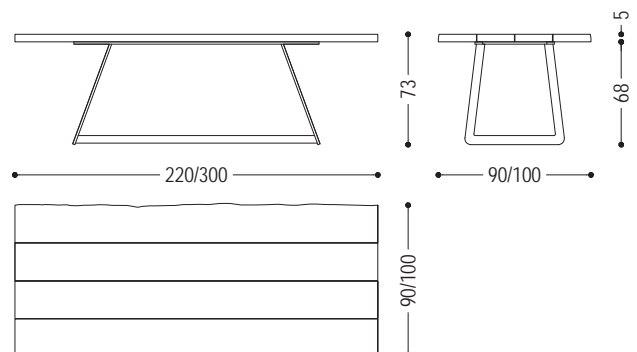

# CALLE CULT NATURAL SIDES | AVAILABLE FINISHES

## WOOD

A1



walnut with knots

A2



oak with knots

A4



oak without knots pigmented:  
white milk



oak with knots pigmented:  
white milk



oak with knots pigmented:  
total black

## IRON

B2

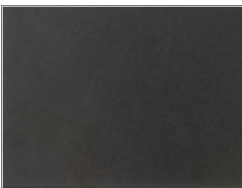

lacquered iron:  
iron dust

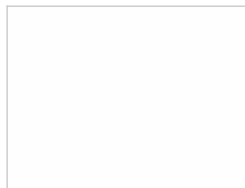

ferro laccato:  
RAL - 1013\_OYSTER WHITE

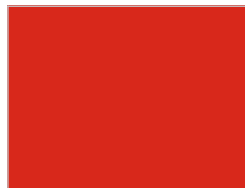

ferro laccato:  
RAL - 3020\_TRAFFIC RED

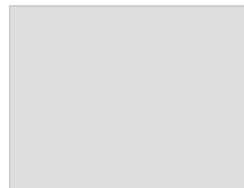

ferro laccato:  
RAL - 7035\_LIGHT GREY

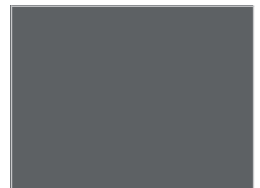

ferro laccato:  
RAL - 7037\_DUSTY GREY

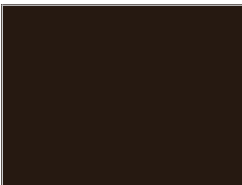

ferro laccato:  
RAL - 8019\_GREY BROWN

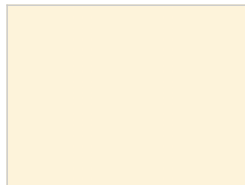

ferro laccato:  
RAL - 9001\_CREAM WHITE

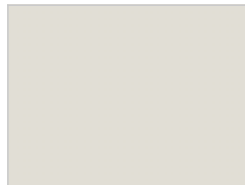

ferro laccato:  
RAL - 9002\_GREY WHITE

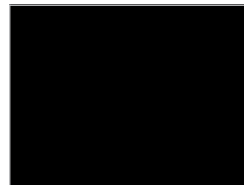

ferro laccato:  
RAL - 9005\_JET BLACK

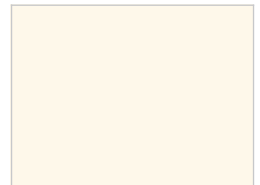

ferro laccato:  
RAL - 9010\_PURE WHITE



ferro laccato:  
RAL - 9016\_TRAFFIC WHITE

# CALLE CULT NATURAL SIDES | AVAILABLE FINISHES

---

B3

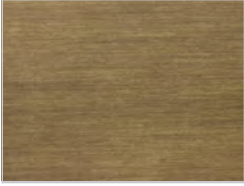

lacquered iron, matt brushed effect:  
aged bronze



lacquered iron, matt brushed effect:  
stainless steel

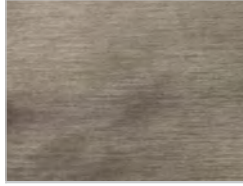

lacquered iron, matt brushed effect:  
titanium