



Armchair with solid wood structure, with backrest and comfortable padded seat, upholstered in leather or fabric with visible stitching.

CODE	SIZE	FOR STRUCTURE ONLY		
		A1	A2	A4
NOBLÉ ARMCHAIR	W.73 x D.76 x H.44/75	■	■	■

AVAILABLE FINISHES:

A1: walnut without knots

A2: oak without knots, cherry

A4: oak without knots pigmented: white milk, total black
oak with knots pigmented: white milk

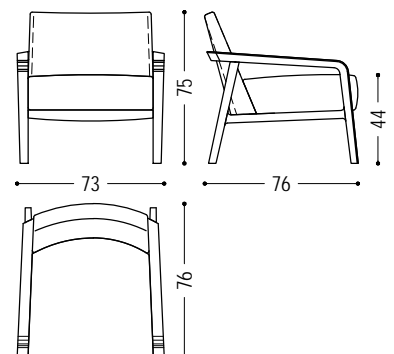

NOBLÉ ARMCHAIR | AVAILABLE FINISHES

WOOD

A1

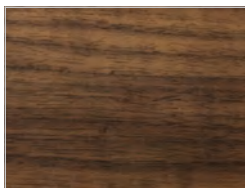

walnut without knots

A2

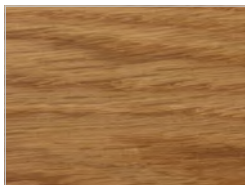

oak without knots

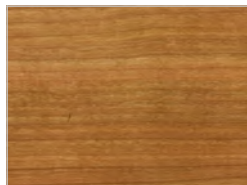

cherry

A4

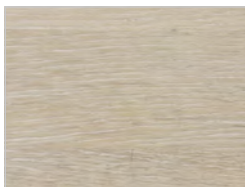

oak without knots pigmented:
white milk



oak without knots pigmented:
total black



oak with knots pigmented:
white milk

NOBLÉ ARMCHAIR | AVAILABLE FINISHES

LEATHER / FABRIC



fabric:
canvas:
114

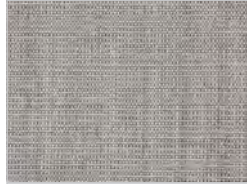

fabric:
canvas:
124

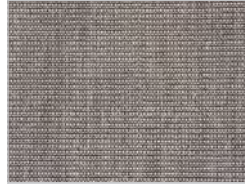

fabric:
canvas:
134

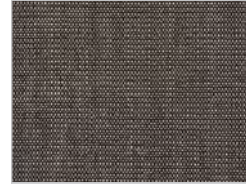

fabric:
canvas:
154



fabric:
canvas:
174



milano m 107:
01 ecru



milano m 107:
02 tortora



milano m 107:
05 orione



milano m 107:
06 azzurro



milano m 107:
07 fiorito



milano m 107:
09 verde

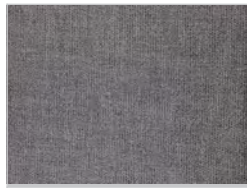

milano m 107:
19 blu



milano m 107:
20 mattone

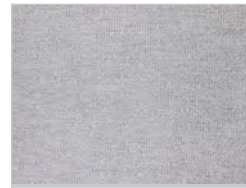

milano m 107:
22 ghiaccio



milano m 107:
25 amaranto

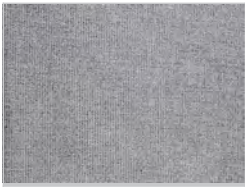

milano m 107:
26 nero

D1



Tokyo M 115:
05 erba



Tokyo M 115:
06 bosco



Tokyo M 115:
08 jeans



Tokyo M 115:
09 blu

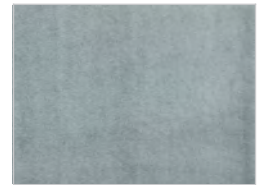

Tokyo M 115:
11 perla



Tokyo M 115:
14 rosso



Tokyo M 115:
23 senape



Tokyo M 115:
29 nocciola



Tokyo M 115:
31 amaranto



Tokyo M 115:
34 tortora



Tokyo M 115:
37 marrone

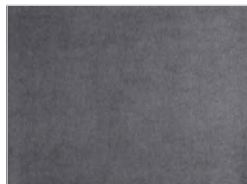

Tokyo M 115:
38 nero



bouclé - m 150:
01 senape

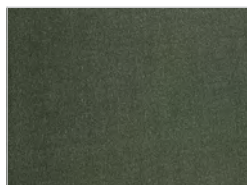

bouclé - m 150:
03 bosco

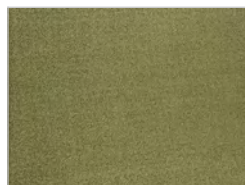

bouclé - m 150:
04 erba

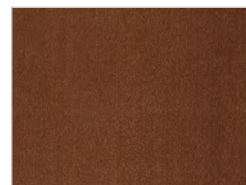

bouclé - m 150:
06 mattone

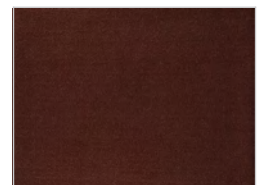

bouclé - m 150:
07 terra

NOBLÉ ARMCHAIR | AVAILABLE FINISHES

D1



bouclé - m 150:
08 amaranto



bouclé - m 150:
11 blu



bouclé - m 150:
12 azzurro

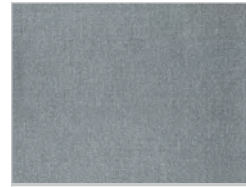

bouclé - m 150:
15 grigio perla



bouclé - m 150:
17 grigio



bouclé - m 150:
18 nero



bouclé - m 150:
20 marrone



bouclé - m 150:
24 tortora



bouclé - m 150:
26 ecru

D2

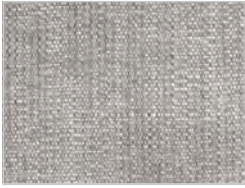

fabric:
maple:
112



fabric:
maple:
132



fabric:
maple:
142



fabric:
maple:
162



fabric:
maple:
192



fabric:
maple:
222



fabric:
maple:
232



fabric:
maple:
362

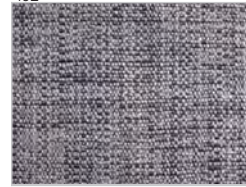

fabric:
maple:
742



fabric:
maple:
792

NOBLÉ ARMCHAIR | AVAILABLE FINISHES

D3



Leather camoscio:
1



Leather camoscio:
10

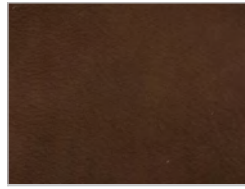

Leather camoscio:
11



Leather camoscio:
26



Leather camoscio:
27

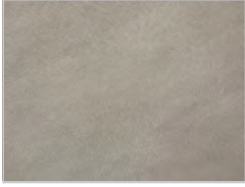

Leather camoscio:
28



Leather camoscio:
31



Leather cristal:
13



Leather cristal:
14



Leather cristal:
17

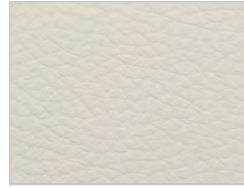

Leather cristal:
18



Leather cristal:
37



Leather cristal:
49



Leather cristal:
51



Leather cristal:
65

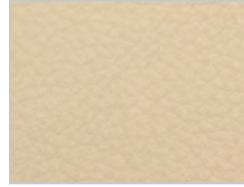

Leather cristal:
70

NOBLÉ ARMCHAIR | AVAILABLE FINISHES

D4					
	Leather utah: 101	Leather utah: 102	Leather utah: 103	Leather utah: 104	Leather utah: 105
					
	Leather utah: 106	Leather utah: 107	Leather utah: 108		
					
	Leather nabuk: 6	Leather nabuk: 12	Leather nabuk: 15	Leather nabuk: 18	Leather nabuk: 23
					
	Leather nabuk: 27	Leather nabuk: 28	Leather nabuk: 30	Leather nabuk: 36	Leather nabuk: 42