



Round small table with solid wood top made of glued lists, combined with an iron base. Available in different sizes, with possibility of stacking one over the other.

CODE	SIZE	BASE	A1	A2	A4
KOHI-WOOD1	Ø 65 x H.22	B2	■	■	■
		B3	■	■	■
KOHI-WOOD2	Ø 65 x H.32	B2	■	■	■
		B3	■	■	■
KOHI-WOOD3	Ø 95 x H.22	B2	■	■	■
		B3	■	■	■
KOHI-WOOD4	Ø 95 x H.32	B2	■	■	■
		B3	■	■	■

AVAILABLE FINISHES:

A1: walnut without knots, walnut with knots

A2: oak without knots, oak with knots, cherry

A4: oak without knots pigmented: white milk, total black
oak with knots pigmented: white milk, total black

B2: lacquered iron: irondust, RAL (only selected colours)

B3: lacquered iron matt brushed effect: aged bronze, stainless steel, titanium

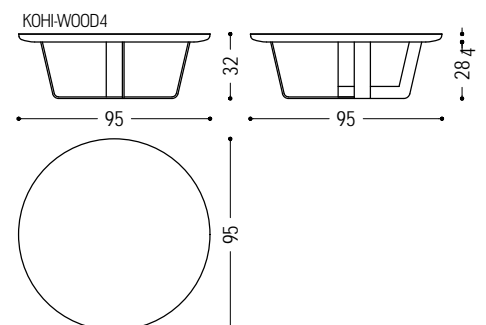
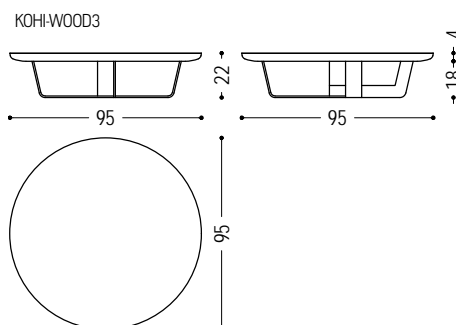
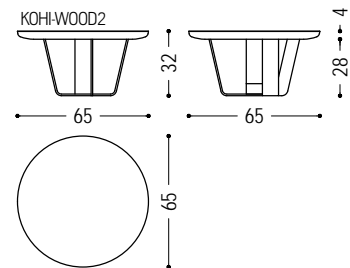
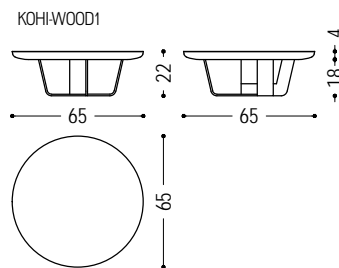

KOHI WOOD | AVAILABLE FINISHES

WOOD

A1

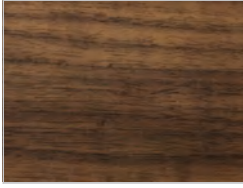

walnut without knots



walnut with knots

A2

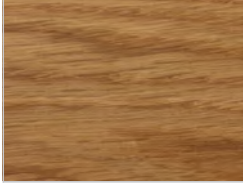

oak without knots



oak with knots

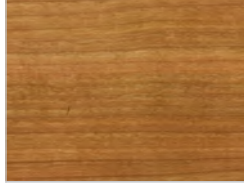

cherry

A4



oak without knots pigmented:
white milk



oak without knots pigmented:
total black



oak with knots pigmented:
white milk



oak with knots pigmented:
total black

IRON

B2

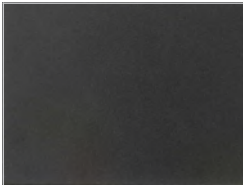

lacquered iron:
iron dust

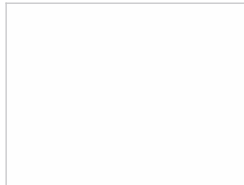

ferro laccato:
RAL - 1013_OYSTER WHITE



ferro laccato:
RAL - 3020_TRAFFIC RED

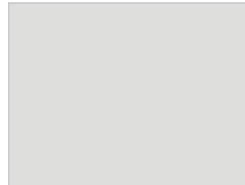

ferro laccato:
RAL - 7035_LIGHT GREY



ferro laccato:
RAL - 7037_DUSTY GREY

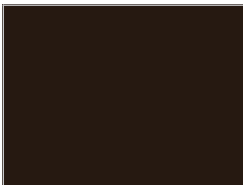

ferro laccato:
RAL - 8019_GREY BROWN

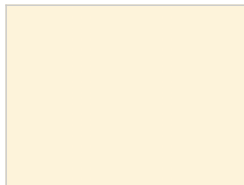

ferro laccato:
RAL - 9001_CREAM WHITE

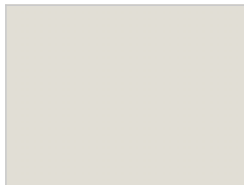

ferro laccato:
RAL - 9002_GREY WHITE

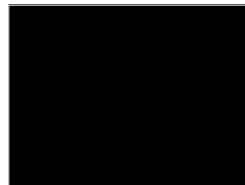

ferro laccato:
RAL - 9005_JET BLACK

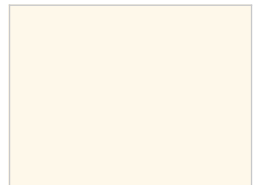

ferro laccato:
RAL - 9010_PURE WHITE



ferro laccato:
RAL - 9016_TRAFFIC WHITE

KOHI WOOD | AVAILABLE FINISHES

B3

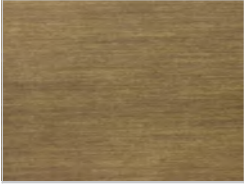

lacquered iron, matt brushed effect:
aged bronze

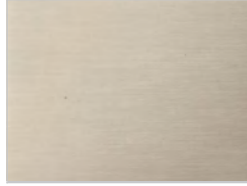

lacquered iron, matt brushed effect:
stainless steel

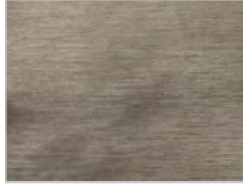

lacquered iron, matt brushed effect:
titanium