



big wave

DESIGN LUDOVICA
+ ROBERTO PALOMBA

modello registrato
registered model

portata sul piano: 150 kg
load capacity on top: 150 kg
art. BW-300, BW-360: 200 kg

Tavolo con base composta da quattro o sei elementi in DV Glass da 30 mm a strisce colorate. Piano temperato in vetro da 15 mm trasparente retroverniciato con tinte monocromatiche, oppure ricoperto in Ecomalta, spatolatura tipo fine, oppure in legno impiallacciato noce canaletto finitura Tabacco.

Table with base made of four or six separate 30 mm DV Glass elements with colored stripes. Tempered top made of 15 mm transparent glass, back-lacquered with monochrome colors or hand-finished with Ecomalta, finergrained texture finish, or in Canaletto walnut veneered wood, Tobacco finish.

SOLO VERSIONE CON TOP IN LEGNO
ONLY WITH WOOD TOP

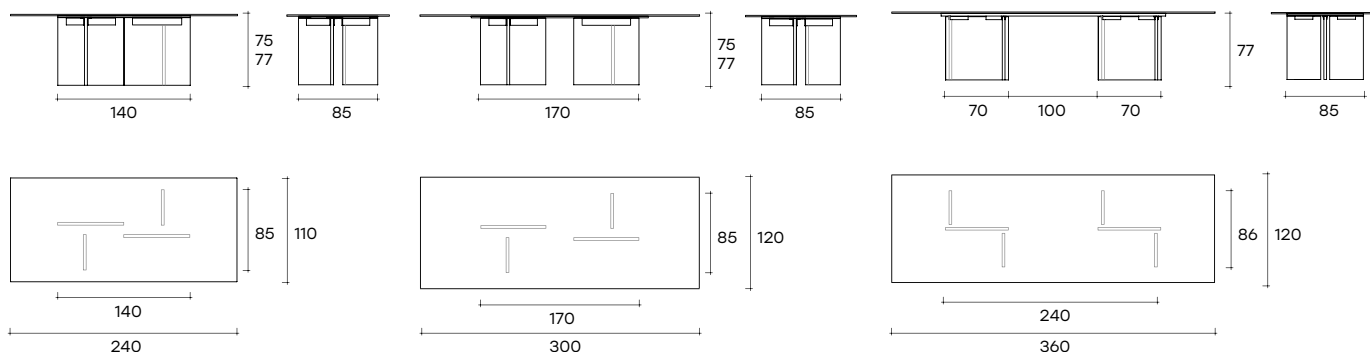

STRUTTURA DV-GLASS®
DV-GLASS® STRUCTURE

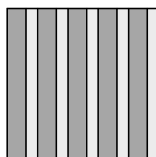
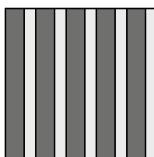
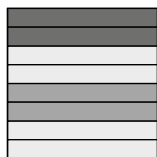

- Trasparente
Transparent
- Fumè
Smoke
- Bronzo
Bronze

Per combinazioni su richiesta,
contattare il customer service.

For customized compositions
please contact Fiam customer service.

dimensioni L, P, H dimensions L, W, H (cm)	COD./CODE	L	P/W	H	peso netto net weight (kg)	peso lordo gross weight (kg)	volume imballo package volume (m ³)
Tavolo con piano in vetro trasparente retroverniciato in tinta Cat.1. Base in DV Glass a strisce colorate. Table with top in transparent glass, back-lacquered - color Cat.1. Base made of colored DV glass.	BW-CO240/V-	240	110	75	237	316	0,9
	BW-CO300/V-	300	120	75	278	373	1,05
Tavolo con piano in vetro ricoperto in Ecomalta finitura Nero Assoluto, Base in DV Glass a strisce verticali fumè e trasparenti. table with glass top hand-finished with ecomalta, Absolute Black finish. Base in DV-Glass made of smoked and transparent vertical stripes.	BW-FU240/MNE	240	110	75	237	316	0,9
	BW-FU300/MNE	300	120	75	278	373	1,05
Tavolo con piano in vetro ricoperto in Ecomalta finitura Tabacco. Base in DV Glass a strisce verticali bronzo e trasparenti. Table with glass top hand-finished with ecomalta, Tobacco finish. Base in DV-Glass made of bronze and transparent vertical stripes.	BW-BR240/MTA	240	110	75	237	316	0,9
	BW-BR300/MTA	300	120	75	278	373	1,05

dimensioni L, P, H dimensions L, W, H (cm)	COD./CODE	L	P/W	H	peso netto net weight (kg)	peso lordo gross weight (kg)	volume imballo package volume (m ³)
Tavolo con piano in legno impiallacciato noce canaletto finitura Tabacco. Base in DV Glass a strisce verticali bronzo e trasparenti. <i>Table with Canaletto walnut veneered wood, Tobacco finish. Base in DV-Glass made of bronze and transparent vertical stripes.</i>	BW-BR240/NT	240	110	77	213	250	0,64
	BW-BR300/NT	300	120	77	245	283	0,72
	BW-BR360/NT	360	120	77	313	363	0,92

VETRO RETROVERNICIATO _ BACK PAINTED GLASS

CAT. COLORE COLOR CAT.	COLORI COLORS	CODICE _ CODE	
		Vetro trasparente _ Transparent glass	
CAT.1 Tinta unita Plain color	Grigio grafite Grey graphite	V-GR	
	Testa di moro Dark brown	V-MR	

Il piano può essere realizzato anche con colori Cat. 2. Per la scelta dei colori fare riferimento alla tabella nella bandella di copertina. Massima dimensione realizzabile per top laccato Cat. 1, 2 - 300x120 o ø 180.

The top can be realized also with colours Cat.2. For the choice of the colours please refer to the chart in the fold flap cover. Max feasible dimension for lacquered top Cat.1, 2 - 300x120 or ø 180.

Per misure e finiture su richiesta rivolgersi all'ufficio commerciale.
For customized dimensions and finishes contact FIAM customer service.

DIMENSIONI CUSTOM _ CUSTOM DIMENSIONS

		DIMENSIONE PIANO _ TOP DIMENSION	
		min.	max.
DIMENSIONE BASE BASE DIMENSION	L 140 cm	200x110 cm	240x110 cm
	L 170 cm	245x110 cm	300x120 cm
	L 240 cm	310x110 cm	360x120 cm

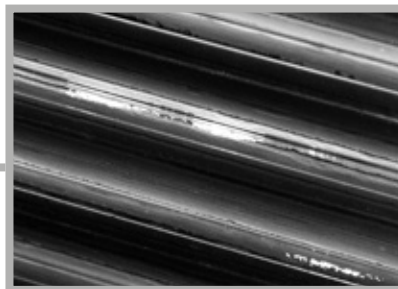
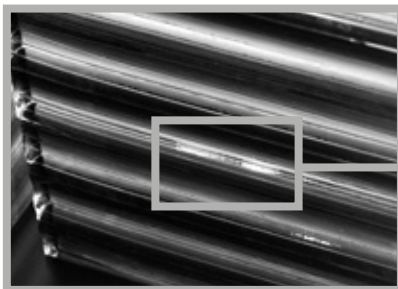

Lievi tracce, avvallamenti superficiali ed irregolarità interne ed esterne alla lastra in vetro sono segni distintivi del processo di fusione ad alta temperatura che ne garantiscono l'artigianalità. Non possono quindi essere oggetto di contestazione.

Slight traces on the surface, internal and external glass plate's irregularities are distinctive signs of the high-temperature fusion process that guarantee its craftsmanship. They cannot therefore be contested.

big wave

DESIGN LUDOVICA
+ ROBERTO PALOMBA

modello registrato
registered model

portata sul piano: 150 kg
load capacity on top: 150 kg
art. BW-300, BW-360: 200 kg



Tavolo tondo con base composta da tre o quattro elementi in DV Glass da 30 mm a strisce colorate. Piano in vetro temperato da 15 mm trasparente retroverniciato con tinte monocromatiche, oppure ricoperto in Ecomalta, spatolatura tipo fine.

Round table with base made of three or four separate 30 mm DV Glass elements with colored stripes. Top made of 15 mm transparent, tempered glass, back-lacquered with monochrome color or hand-finished with Ecomalta, finer-grained texture finish.

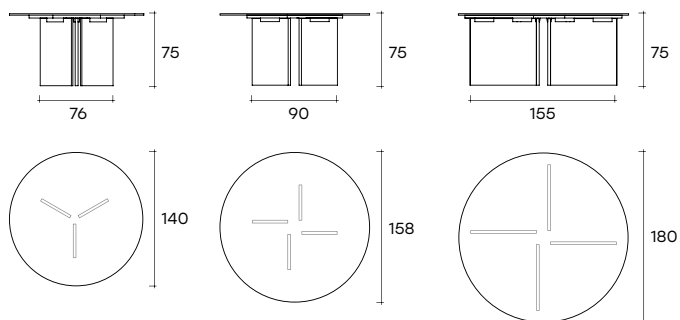

STRUTTURA DV-GLASS® DV-GLASS® STRUCTURE

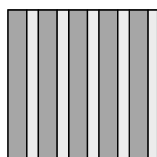
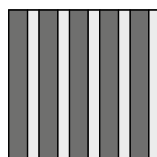
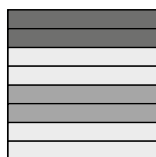

- Trasparente
Transparent
- Fumè
Smoke
- Bronzo
Bronze

Per combinazioni su richiesta,
contattare il customer service.

For customized compositions
please contact Fiam customer service.

dimensioni Ø, P, H dimensions Ø, W, H (cm)	COD./CODE	Ø	P/W	H	peso netto net weight (kg)	peso lordo gross weight (kg)	volume imballo package volume (m³)
Tavolo con piano in vetro trasparente retroverniciato in tinta Cat.1. Base in DV Glass a strisce colorate. Table with top in transparent glass, back-lacquered - color Cat.1. Base made of colored DV glass.	BW-COR140/V-...	Ø140	-	75	99	189	0,68
	BW-COR158/V-...	Ø158	-	75	170	237	0,79
	BW-COR180/V-...	Ø180	-	75	268	368	1,14
Tavolo con piano in vetro ricoperto in Ecomalta finitura Nero Assoluto. Base in DV Glass a strisce fumè e trasparenti. Table with glass top hand-finished with ecomalta, Absolute Black finish. Base in DV-Glass made of smoked and transparent vertical stripes.	BW-FUR140/MNE	Ø140	-	75	100	190	0,68
	BW-FUR158/MNE	Ø158	-	75	170	237	0,79
	BW-FUR180/MNE	Ø180	-	75	270	370	1,14
Tavolo con piano in vetro ricoperto in Ecomalta finitura Tabacco. Base in DV Glass a strisce verticali bronzo e trasparenti. Table with glass top hand-finished with ecomalta, Tobacco finish. Base in DV-Glass made of bronze and transparent vertical stripes.	BW-BRR140/MTA	Ø140	-	75	100	190	0,68
	BW-BRR158/MTA	Ø158	-	75	170	237	0,79
	BW-BRR180/MTA	Ø180	-	75	270	370	1,14

VETRO RETROVERNICIATO _ BACK PAINTED GLASS

CAT. COLORE COLOR CAT.	COLORI COLORS	CODICE _ CODE	
		Vetro trasparente _ Transparent glass	
CAT.1 Tinta unita Plain color	Grigio grafite Grey graphite	V-GR	
	Testa di moro Dark brown	V-MR	

Il piano può essere realizzato anche con colori Cat. 2. Per la scelta dei colori fare riferimento alla tabella nella bandella di copertina. Massima dimensione realizzabile per top laccato Cat. 1, 2 - 300x120 o ø 180.

The top can be realized also with colours Cat.2. For the choice of the colours please refer to the chart in the fold flap cover. Max feasible dimension for lacquered top Cat.1, 2, 3 - 300x120 or ø 180.

Per misure e finiture su richiesta rivolgersi all'ufficio commerciale.
For customized dimensions and finishes contact FIAM customer service.

DIMENSIONI CUSTOM _ CUSTOM DIMENSIONS

		DIMENSIONE PIANO _ TOP DIMENSION	
		min.	max.
DIMENSIONE BASE BASE DIMENSION	L 76 cm	Ø 120 cm	Ø 140 cm
	L 90 cm	Ø 145 cm	Ø 175 cm
	L 155 cm	Ø 180 cm	Ø 220 cm

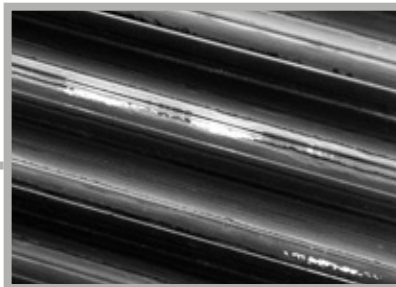
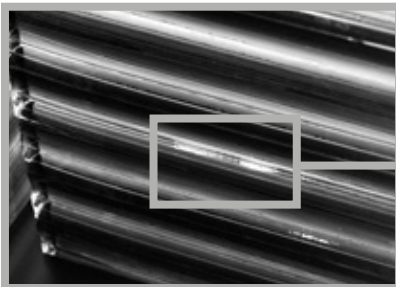

Lievi tracce, avvallamenti superficiali ed irregolarità interne ed esterne alla lastra in vetro sono segni distintivi del processo di fusione ad alta temperatura che ne garantiscono l'artigianalità. Non possono quindi essere oggetto di contestazione.

Slight traces on the surface, internal and external glass plate's irregularities are distinctive signs of the high-temperature fusion process that guarantee its craftsmanship. They cannot therefore be contested.

FINITURE
FINISHES

Base in DV-Glass®
DV-Glass® base

vetro fuso colorato
fused colored glass

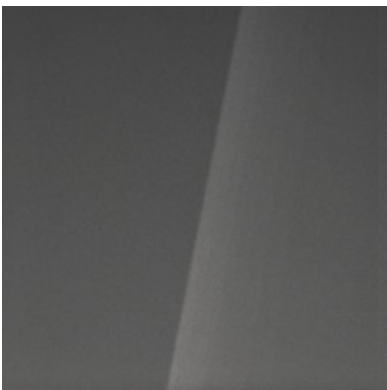
Piano in vetro verniciato
Back-painted glass top

grigio grafite
graphite grey

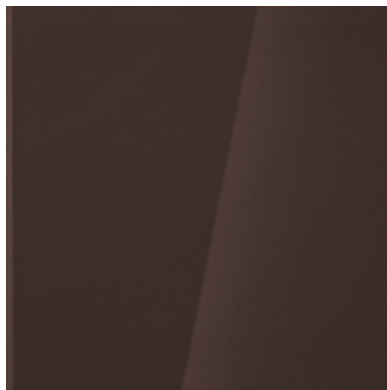

marrone testa di moro
dark brown

FINITURE
FINISHES

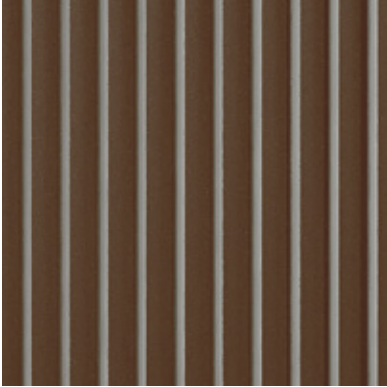
Base in DV-Glass®**DV-Glass® base**

vetro fuso bronzo e trasparente
fused bronze
and transparent glass



vetro fuso fumè e trasparente
fused smoked
and transparent glass

Piano in vetro spatolato con Ecomalta®**Ecomalta® finish glass top**

tabacco
tobacco

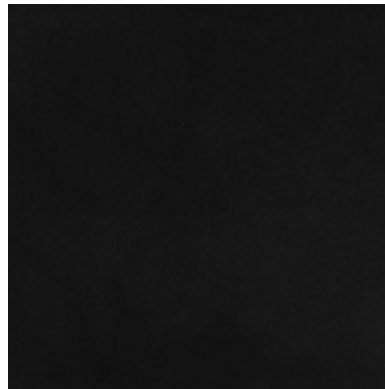

nero assoluto
absolute black

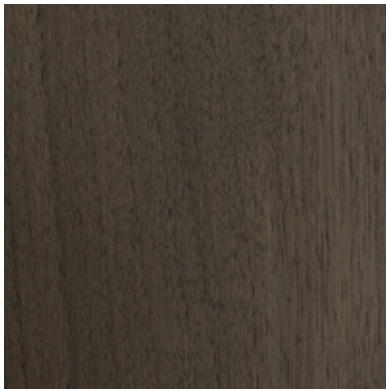
Piano in legno**Wood top**

noce canaletto finitura tabacco
canaletto walnut, tobacco finish